

## EV Traction Dry Cell Industrial Battery Block

Discover<sup>®</sup> EV Series Industrial Batteries provide superior high integrity and reliability for commercial, industrial and private applications. The maintenance-free, thick plate construction, designed for tough applications and repeated deep discharging makes the EV Series the definitive choice for robust Traction applications including Home Medical Equipment (HME), Electric Vehicle, Automated Guided Vehicles (AGV), Aerial Lifts, Floor Cleaning Equipment, Robotics, Materials Handling, Renewable Energy and Marine / RV applications.

### MECHANICAL DRAWINGS

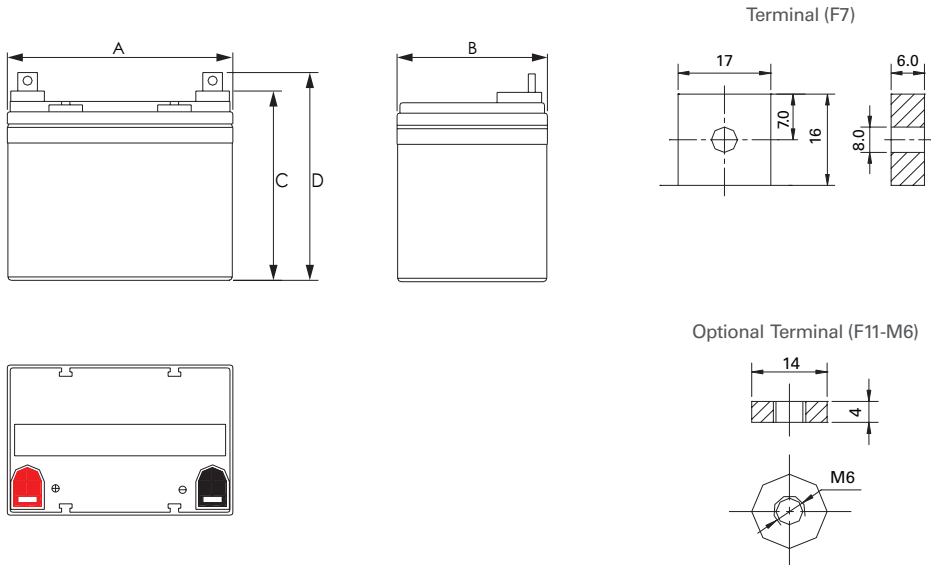

### MECHANICAL SPECIFICATIONS

Industry Reference	U1	
Length (A)	7.7 in	195 mm
Width (B)	5.1 in	130 mm
Height (C)	6.5 in	164 mm
Total Height (D)	7.1 in	180 mm
Weight	23 lbs	11 kgs
Terminal (Opt'l)*	F7 (F11-M6)	
Cell(s)	6	
Electrolyte	1.2875 S.G.	AGM

\*TERMINAL TORQUE: Please refer to our document, located in the Resources webpage ([www.discoverbattery.com/resources](http://www.discoverbattery.com/resources)).

### ELECTRICAL SPECIFICATIONS

Voltage	12 V	
80% DOD Voltage Cutoff	11.4 V	
Internal Resistance	7.30 mΩ	
Short Circuit (20°C   68°F)	1520 A	
Self Discharge	Less than 3% per month (20°C 68°F)	
Cranking Amps**	245 @ 0°C (32°F)	205 @ -18°C (0°F)
Charge Temperature	Min: -10°C (-14°F)   Max: 50°C (122°F)	
Discharge Temperature***	Min: -20°C (-4°F)   Max: 50°C (122°F)	
Storage	Min: -20°C (-4°F)   Max: 60°C (140°F)	

\*\*CRANKING AMPS: Cranking Amps data is provided as a reference only. Specific application sizing and life factors must be considered when using deep cycle product in a starting application.

\*\*\*CAUTION: Extra considerations must be given to depths of discharge, operating voltages and currents when designing systems for use at maximum temperatures.

### ELECTRICAL SPECIFICATIONS

Amp Hours (AH)						Minutes of Discharge				
100 HR	20 HR	10 HR	5 HR	3 HR	1 HR	@25A	@56A	@75A	@85A	@100A
37	33	31	28	25	20	45	17	12	9	7

Maximum Current	Peak (5 seconds)	Peak (10 seconds)	Continuous	Recommended Continuous
Charge	1C10Hr	0.75C10Hr	0.5C10Hr	0.3C10Hr
Discharge	2C10Hr	1.5C10Hr	1C10Hr	0.5C10Hr

### BENEFITS & FEATURES

Maintenance-Free Clean & Green<sup>®</sup> choice of Original Equipment Manufacturers.

Traction heavy duty grid design (PbCaSn) gives consistent active material adhesion and corrosion resistance.

High impact reinforced copolymer and polypropylene cases with flat top designs.

A recognized gas recombination efficiency of greater than 99.9%.

Multiple terminal, configuration options and carrying handles available with most models.

Classified as a non-spillable battery and is not restricted for transportation by:

- Air (IATA/ICAO provision 67)
- Ground (STB, DOT-CFR-HMR49)
- Water (IMDG amendment 27)

Compatible with sensitive electronic equipment.

Comprehensive design to conserve resources, improve safety and reduce waste. 98% recyclable.

### CERTIFIED QUALITY

Designed in accordance with and published in compliance with applicable BCI, IEC and BS EN standards, including:

- IEC60896-21/22
- BS EN 60254-1:2005
- AS/NZS 4029.2:2000

Discover<sup>®</sup> and its facilities and products are certified to multiple standards:

- ISO, UL, QS, and TUV standards
- ETTS Germany
- Euro Bat classification for Environmental Stewardship Standards



**NOTE:**

IUI with Pulse Termination algorithm uses a pulse termination criterion. As a safety precaution during the Finish phase, if the average cell voltage, or volts per cell (vpc), exceeds U2 and the charger output has been on for more than 30 seconds, the output is shut off until the vpc falls to U3. The finish phase then resumes and this "pulsing" continues until the target overcharge (108% - 112%) is reached.

**NOTE 2:**

Temperature Coefficient: Adjust +/- 0.005VPC per °C (or 0.003VPC per °F) from 25°C (77°F).

**TEMPERATURE EFFECTS ON CAPACITY**

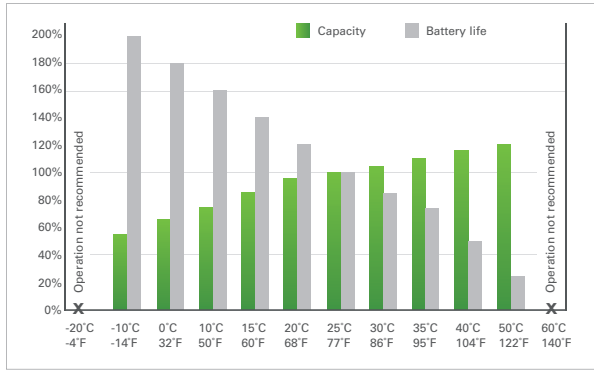

**CYCLE LIFE IN RELATION TO DEPTH OF DISCHARGE (25°C)**

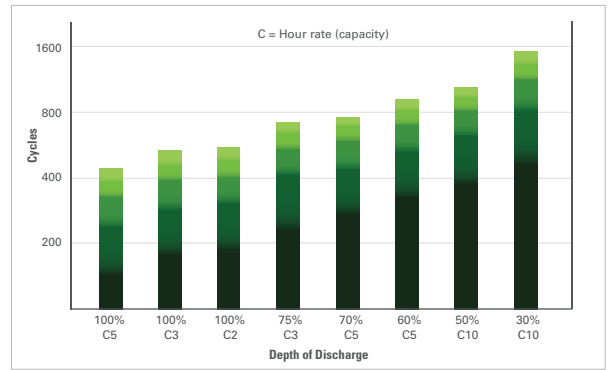

**OPEN CIRCUIT VOLTAGE IN RELATION TO THE STATE OF CHARGE (20°C)**

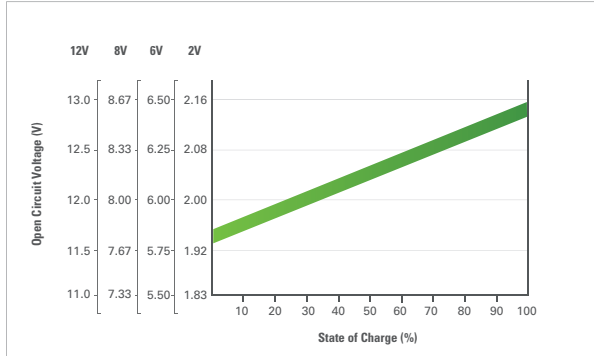

**SELF-DISCHARGE CHARACTERISTICS**

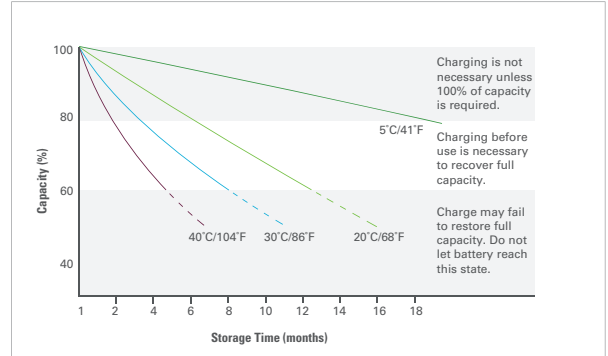

**IUI WITH PULSE TERMINATION CHARGE PROFILE**

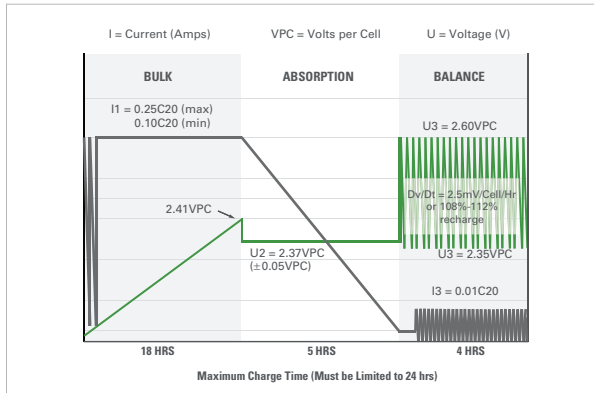

**IUI CHARGE PROFILE**

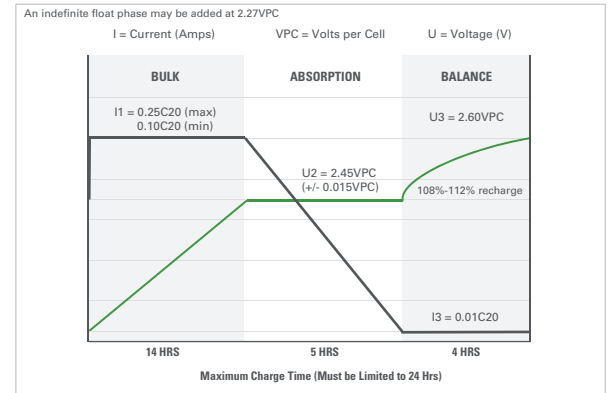

**IUO CHARGE PROFILE**

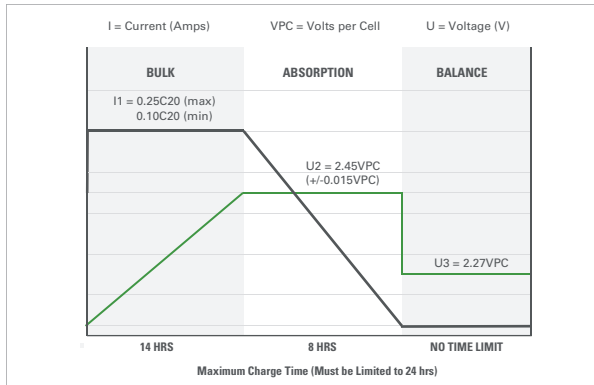

**RELATION BETWEEN CHARGING, VOLTAGE AND TEMPERATURE**

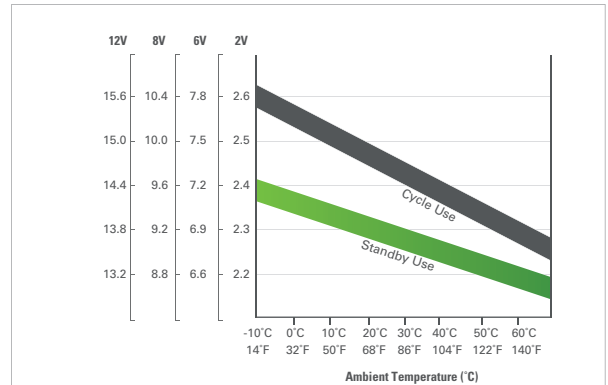

Discover® attempts to ensure the correctness of the product description and data contained herein. We reserve the right to change designs, specifications and pricing at any time without notice or obligation. It is the responsibility of the reader of this information to verify any and all information presented herein.